



VACUUM CONVEYING 5.0

Simplifying material handling



**HOANG LONG
TECHNOLOGY**

Always for your product quality

Index

Piab Vacuum Academy	5	Selection data – piFLOW®p	49
PVA emphasizes the basics	5	Legend – piFLOW®p	50
A typical vacuum conveying system	6	Legend – piFLOW®i/f	52
Material handling	6	Selection data – piFLOW®i/f	53
Pneumatic Conveying system	10	Warranties	54
Components of vacuum conveying	11		
System design	13		
Application illustrations	16		
Vacuum pumps	20		
Tables	22		
Standards	26		
piFLOW®	31		
Industrial – piFLOW®i	34		
Food grade – piFLOW®f	36		
Premium – piFLOW®p	38		
piFLOW® – Conveyor Customer Code	40		
Accessories & spare parts	43		
Accessories	44		
Spare parts	48		

Piab Vacuum Academy

1. Piab vacuum academy emphasizes the basics

In industry today there is an accelerating trend toward ever more customized solutions that can be made available at short notice. Product development times and production runs are both becoming shorter. Changes are becoming more sudden and harder to predict. Competence and willingness to change are being challenged by a never-ending parade of new situations. Training that sharpens skills and broadens perspectives enables your personnel – and your company – to handle more sophisticated assignments while accepting highly qualified responsibilities. This makes it easier for you to develop new functions and work procedures while advancing into new markets.

1.1 Principles of conveying

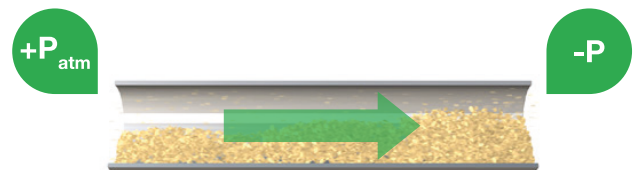

In the field of vacuum conveying technology we speak of vacuum conveyors being used for “sucking” material. What actually happens is that the air is evacuated from the suction pipe and the pressure of the atmosphere pushes the material into the suction pipeline. It is the atmospheric pressure that indirectly performs the work. The stream of air that is formed upon pressure equalization pulls the solid particles into the pipeline.

All vacuum conveyors work according to the same main principle. The material is conveyed from a suction point through a pipeline to a container, where the air and the material are separated. The filter cleans the air before it passes through the vacuum source. A control unit regulates the operating sequence.

2. A typical vacuum conveying system

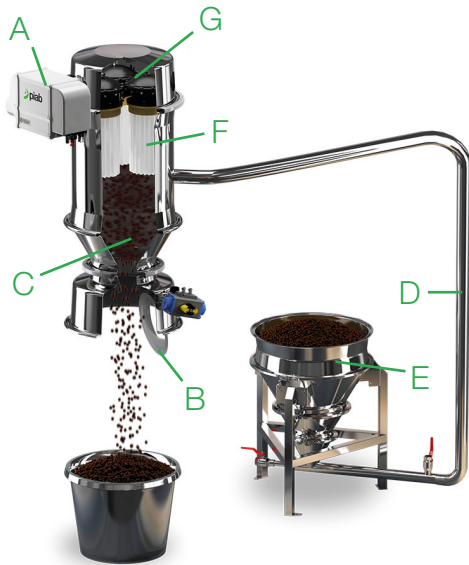

Vacuum is generated by a compressed air-driven vacuum pump (A). The pump can easily be automatically controlled. Since it has few moving parts, the pump is virtually maintenance-free.

1. The bottom valve (B) is closed, and vacuum is raised in the container (C) and the conveying pipeline (D).
2. From the feed station (E) the material is drawn into the conveying pipeline and then on to the container.
3. The filter (F) prevents dust and fine particles from being drawn into the pump and escaping into the surroundings.
4. During the suction period, the filter cleaning device (G) is filled with compressed air.
5. When the material container is full, the vacuum pump is stopped. The bottom valve opens and the material in the container is discharged. At the same time, the compressed air in the filter

cleaning device is released and cleans the filter.

6. When the pump is restarted, the process is repeated and a new cycle begins. The suction and discharge times are normally controlled by pneumatic or electrical control systems.

3. Material handling

3.1 Material flow

The material flow is determined by the:

- Diameter of the conveying pipeline
- The vacuum flow
- Conveying distance
- Characteristics of the material.

Dense phase means that the material is conveyed in separate plugs in the conveying pipeline. Some materials can be conveyed in dense phase.

Another conveying phase is “dilute phase”. Conveying speed in dilute phase is usually >30 ft/s.

The following figure shows conveying phases with different phase densities. From very dilute phase (1), over dense phase (7) to blocked pipeline (8).

$$* \text{ Phase density} = \frac{\text{Material flow (lb/h)}}{\text{Vacuum flow (lb/h)}}$$

It is generally the case that in dense phase, because the material moves in the form of

plugs, the vacuum level is usually 30–65%, while in dilute phase it is 10–30%.

When sizing a conveying installation, it is important to find the optimum conveying phase for a specific material. A common misapprehension is that the greater the vacuum flow, the higher the material flow. The relation between material flow and vacuum flow may, for example, be as shown in the figure. The diagram shows that the maximum material flow Q_{\max} is equivalent to the vacuum flow Q_v . When the vacuum flow increases, the material flow will decrease.

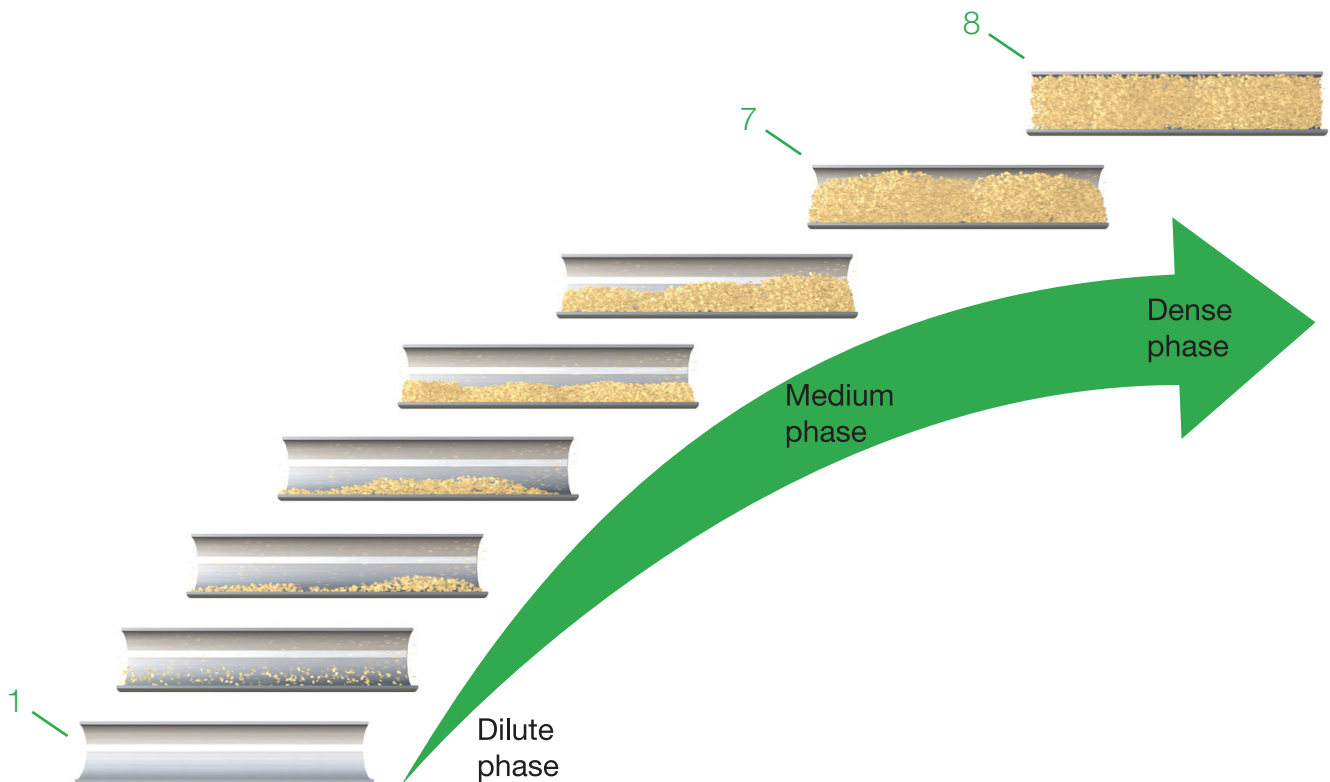
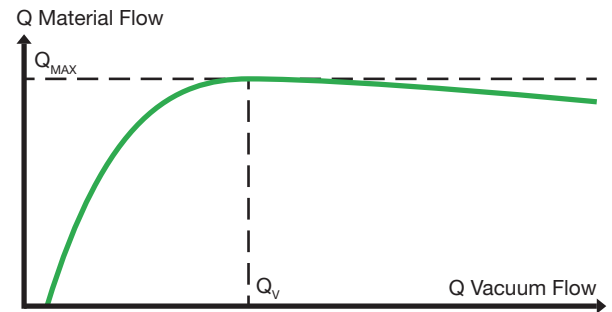

3.2 Material classification

When sizing a conveyor, it is important to determine the fluidity of the material that is to be conveyed.

To sum up, the following points should be included in the material classification:

- Fluidity/angle of repose
- Bulk density
- Abrasion factor
- Particle
 - size
 - distribution
 - form
 - density
 - hardness
- Moisture sensitivity (hygroscopicity)
- Explosion hazard
- Harmfulness/poisonousness

3.2.1 Fluidity

The fluidity is one of the most important qualities when the conveying possibilities of a material shall be decided. One way of making a rough assessment of the fluidity is to determine the material's angle of repose by pouring out the material from a height and measuring the angle (a).

A small angle of repose means good fluidity and a large angle of repose, poor fluidity. The factors that determine the fluidity of the

material are particle size, geometric shape, tendency to pick up static electricity and degree of moisture sensitivity. Plastic granules generally have good fluidity while corn flour has poor fluidity and is also sensitive to moisture.



Material with poor fluidity can often be fluidized. For fluidization to work, the material must be reasonably fine so that it is lifted by the fluidizing air. If the material consists of coarse particles, fluidization will not be so effective.

3.2.2 Bulk density

The term “bulk density” refers to the weight/volume of a material, in other words, how much one cubic foot of the material weighs. As one cubic foot of powder contains both material and air, the bulk density will vary considerably depending on how closely a particular material is packed. In other words, the same material will have different bulk density values if you weigh a cubic foot of material that has been poured into a beaker and a cubic foot of material that has been shaken and packed. It is therefore important to measure bulk density under conditions that are as similar as possible to the actual conveying conditions.



3.2.3 Particles

Individual particle weight, size, distribution, form and hardness are all parameters that determine a material's flow ability and thus its conveying characteristics.

The weight (density and size) of the individual particles determines the vacuum flow that is required to lift the material into the conveyor pipe and move it forward in the pipeline.

The term "particle distribution" refers to how much of various-sized particles, from the smallest to the largest, make up the material's composition.

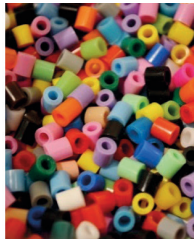

3.2.4 Moisture sensitivity

Different materials are more or less hygroscopic. If test running is carried out on a particular material, it is important that the conditions are kept as similar as possible to those that will apply on installation. A moisture-sensitive material may form lumps that catch in the material intake, stick in the pipeline or block up the filter.



3.2.5 Explosion risk

In connection with handling of finely ground material, there may be a risk of dust explosion. Dust explosions can occur when certain types of particles are mixed with air at a certain ratio and a source of ignition is present. Rapid expansion and pressure increase are characteristics of dust explosions. Dust explosions that occur during conveying of materials are commonly caused by sparks from static electric discharge.

In a vacuum conveyor, the ratio of the air-to-material mixture (phase density) varies and the risk of a dangerous mix cannot be eliminated entirely. The risk of ignition can, on the other hand, be minimized by preventing electrostatic discharge and thus the generation of sparks. This can be achieved by connecting the various parts of the conveyor system to the same earth point (equipotential connection).

Many common materials have a tendency to cause dust explosions. Examples of such materials are given below but of course there are many more.

- Aluminium
- Aspirin
- Carbon
- Coffee
- Cork
- Cotton
- Flour
- Grain
- Iron
- Nylon
- Sugar
- Tea

4. Pneumatic Conveying system

4.1 General

From a technical point of view, pneumatic conveying is based on conveying of solid particles mixed with a gas, usually air. By means of pneumatic conveying, solid particles of varying sizes can be conveyed between points, for example, from a storage to a processing machine.

4.2 Pneumatic conveying systems are divided into two categories:

1. Positive-pressure systems, where the material is blown through the conveying pipeline by compressed air.
2. Negative-pressure systems where the material is “sucked” through the conveying pipeline.

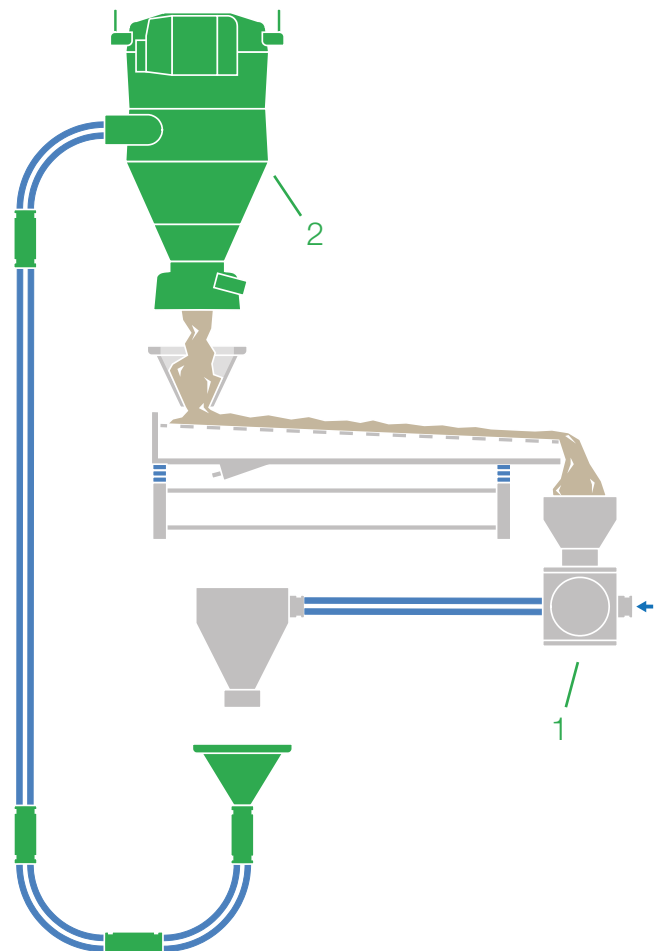

5. Components of a vacuum conveying system

A vacuum conveying system always consists of a number of components. The components are suction point, conveying pipeline, collecting container, filter, vacuum pump and control equipment. Support components may be fluidization, pipeline valves, various sack dischargers, weighing equipment, etc.

5.1 Feeding point

For automatic or semi-automatic systems a feed station or different types of feeding adapters can be used. A feed station is a special feeding adapter that can mix air with the material and, if necessary, be provided with fluidization.



The suction point can also consist of an aspirated feed nozzle, which entrains extra air to the conveying.



A feeding adapter with adjustable intake for air and material, that can be mounted on, for example, a silo.



5.2 Conveyor pipeline

One of the many advantages of pneumatic conveying systems is that they are simple to install. Friction in pipes and hoses can reduce the material flow considerably. For permanent installation, rigid pipes should always be used. Pipes have lower friction than hoses. A good pipe installation may mean an increase in the material flow so that pump capacity can be reduced and thus lower running costs achieved.

5.3 Conveyor body

The collection container is the vessel or volume that is placed under vacuum in connection with the suction cycle and in which the material is collected. At the bottom of the container there is a discharge device that opens when the suction cycle is complete and the material flows out and then closes again in preparation for the next suction cycle.

If necessary, the discharge device may be fitted with fluidization for better discharge.

5.4 Filter



The filter separates the conveyed material from the carrier air. If some particles should follow the air up to the filter, they will be filtered away, and the clean air will continue out through the vacuum pump. Most filters are fitted with some kind of cleaning device.

5.5 Vacuum pump

The heart of the system is the vacuum pump that creates the reduction of pressure or suction that moves the material.

By using a compressed air-driven vacuum pump, a complete explosion-proof unit is achieved, which is important in order to avoid dust explosions. Vacuum pumps driven by compressed air also have the advantage of being virtually maintenance-free, silent and not emitting any heat. They are also easy to control as they react very quickly. The pump can be controlled by means of the compressed air supply, which means that the pump runs only during the suction period and is at rest, saving energy, at other times.

5.6 Control equipment

As a vacuum conveyor works intermittently, some form of control equipment that regulates running time, standstill time, discharge, fluidization, etc., is required.

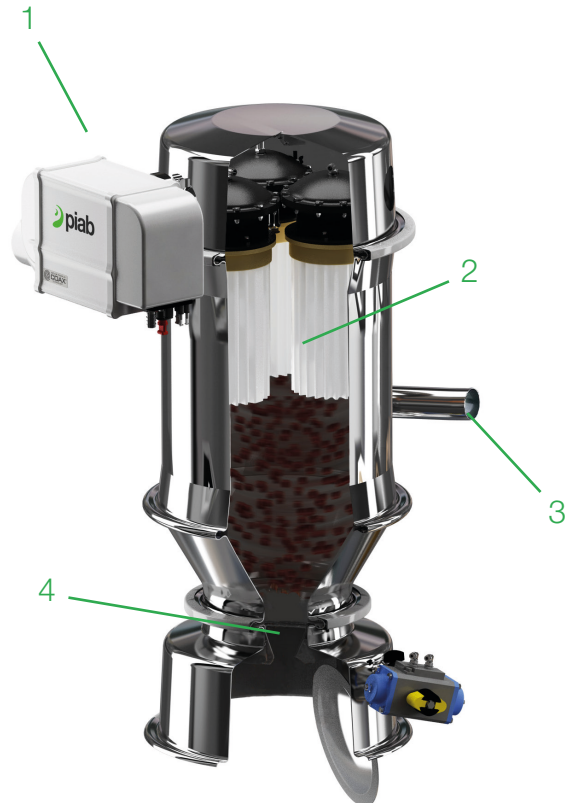

1. Pump unit
2. Filter unit
3. Connection unit
4. Bottom valve unit
5. Control unit (not in picture)
6. Nylon tubing kit (not in picture)

6. System design

As mentioned previously, there are many parameters that affect a vacuum conveying system. Naturally, the system design itself is also extremely important. However, as most vacuum conveying systems are unique it is hard to give direct instructions. Certain general basic principles do of course apply and the most important of these are described below.

6.1 General

Some general rules to bear in mind when planning a vacuum conveying system are:

- Short conveying distance reduces system and running costs.
- Keep number of pipe bends to a minimum to reduce system and running costs.
- Avoid running the conveying pipeline on an inclined plane.
- Use rigid pipes where possible.

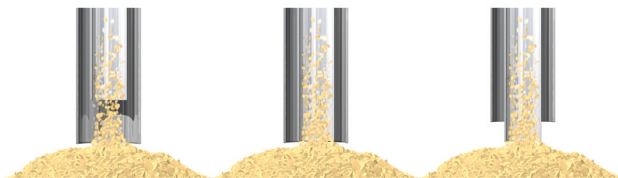

6.2 Suction point design

Most materials need additional air in order to be set in motion. If a system is to function satisfactorily, the feed, i.e., the suction point, must be designed correctly. It is important

that the material is placed close to the intake on the conveying pipeline as the suction capacity decreases by the square of the distance.

When the suction point is designed as a feed station, there are normally two valves, one for air and one for the material, which can be controlled to give the right proportions of material and air in the pipeline. Another way of supplying air, particularly with material that is hard to convey, is to fit the feed funnel with fluidization.

If a suction nozzle is used, the simplest way of supplying additional air is by using a double-mantled feed nozzle, where the input air is regulated by means of a valve on the handle. The inner tube can also be regulated upwards and downwards in relation to the outer one, and this setting also has an effect on conveying.

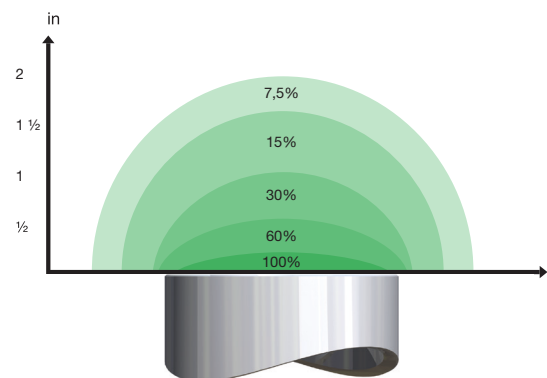

6.3 Pipe dimensions

Pipe diameter is of vital importance for the capacity of a conveying system. In principle, the greater the diameter of the pipe, the greater the capacity of the system, provided the speed is kept constant. In practice this means that if you want to increase the capacity, you usually have to overhaul the entire system, including vacuum pump and containers as well as tube dimensions. In certain cases, however, a capacity increase may be made possible with smaller pipes and the same pump. This is due to the fact that it may be possible to move the material in another phase (dense phase). The ratio of the various pipe diameters is shown by the adjacent figure. For example, a pipe with a diameter of 75 mm (3") is equivalent to two pipes with a diameter of 50 mm (2").

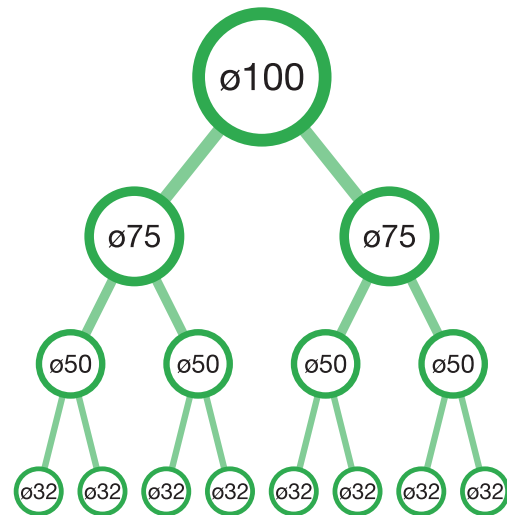

The speed of the material is directly related to the speed of the air in the pipeline. As the pressure in the pipeline falls the closer you get to the conveyor, the speed of the air and the material increases correspondingly. That is why in certain cases stepped pipelines (pipes of increasing diameter) have to be used to keep down the speed of the material so that it is not broken to pieces.

6.4 Pipe bends

A large bending radius is one way of avoiding unnecessary wear and pipeline resistance. Hoses are often used in bends so that they can be simply and cheaply replaced when they wear out.

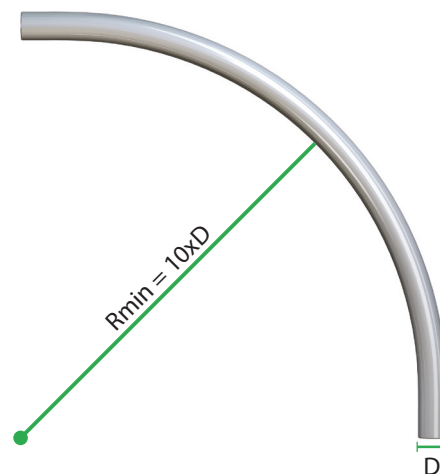

6.5 Pipe joints

Pipe joints must be constructed correctly so that material does not build up around the joints. Rounded edges and a good seal are important points to remember.

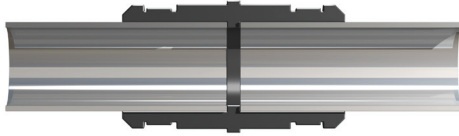

6.6 Fluidization

In cases where the material to be conveyed has poor flow capacity, fluidization may be an option. Fluidization may take place both at the feed station, to ensure supply of material to the conveyor, and in the conveyor container to improve discharge.

Fluidization means that compressed air passes through a porous filter material where it is finely distributed. The finely distributed air creates a cushion or film that reduces the friction quite considerably between material and base. What is more, the air is mixed with the material in such a way that friction is also reduced between the particles in the material, which means that the material “flows like water”. Not all materials can be fluidized.

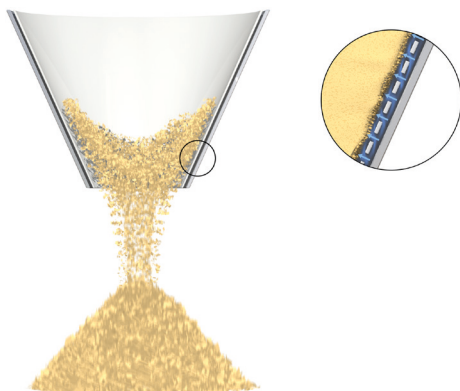

6.7 Weighing

Checking or weighing how much material has been conveyed may take place according to three main principles. The feed station can measure how much has been taken away, the conveyor container can be weighed to measure how much has reached it, and the receiving container may be weighed to ascertain how much has been discharged. Usually, the last weighing option provides the greatest accuracy. The degree of accuracy that can be achieved with the various systems is entirely dependent on the properties of the material conveyed and the construction of the system. In cases where the aim is to meter out a certain quantity of material it is best to place special metering equipment between the conveyor and the receiving container. There are many different types of equipment in the market and the properties of the material determine type and make.

6.8 Several different materials

It is simple to connect a vacuum conveyor to different feed stations and thus it can convey different materials to one and the same container, but only one material at a time. If you want to mix different material to a recipe, the system can be fitted with load cells for weighing.

7. Application illustrations

7.1 Pharmaceutical applications

Feeding a tablet press:

piFLOW[®]p normally used.

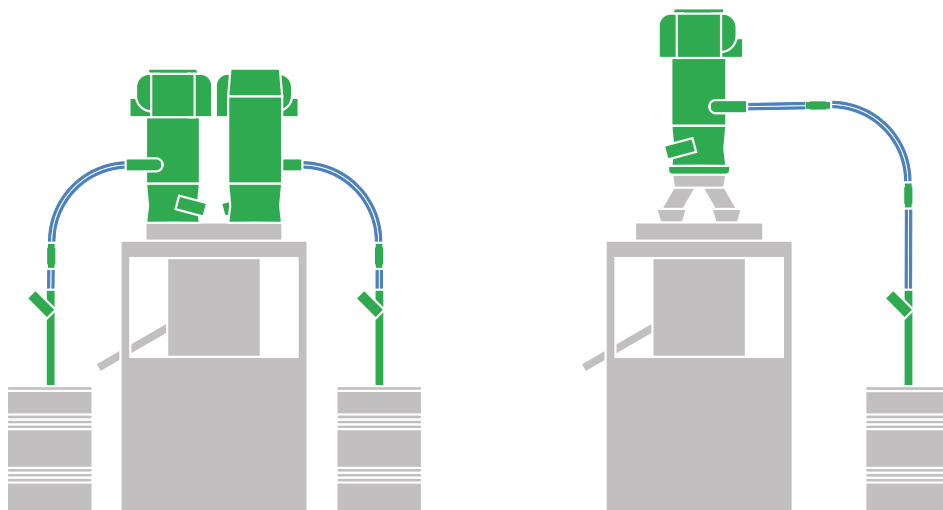

A. Two conveyors transporting material to a tablet press.

B. High speed conveying to a tablet press with a single conveyor. Splitting the feed into two hoppers.

V-blender:

piFLOW[®]p normally used.

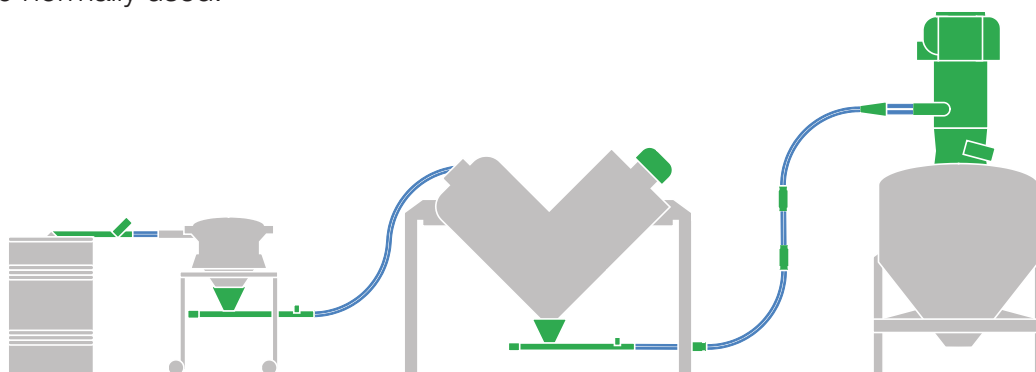

Direct charging a V-blender from a screener. Unloading with a second conveyor.

7.2 Food applications

Coffee application:

piFLOW[®]f and piFLOW[®]p normally used.

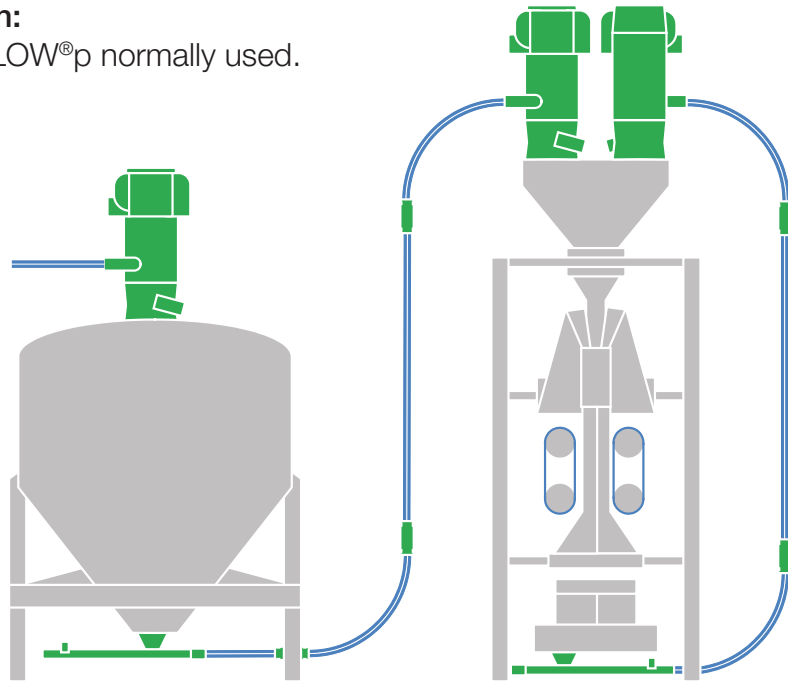

Beans after roasting process into hopper with roasted, stabilized and dried beans. Conveying to portioning machine. Into packaging machine and bags. Reclaiming back to packaging machine.

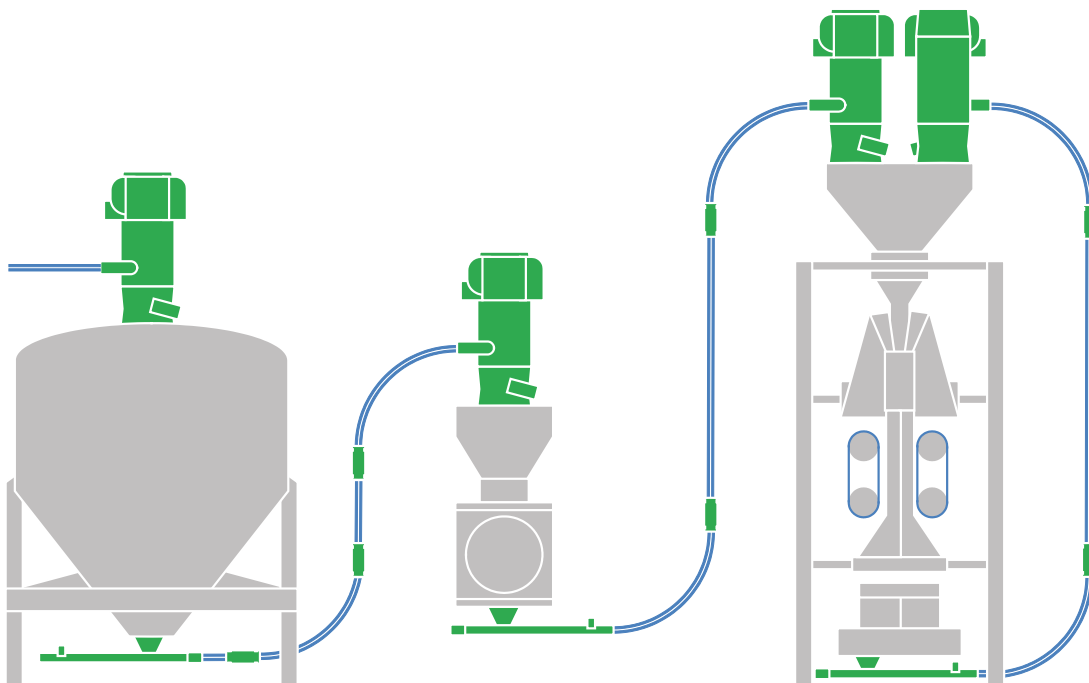

Beans after roasting process into hopper with roasted, stabilized and dried beans. Conveying to Milling process. Conveying to portioning machine. Into packaging machine and bags. Reclaiming back to packaging machine.

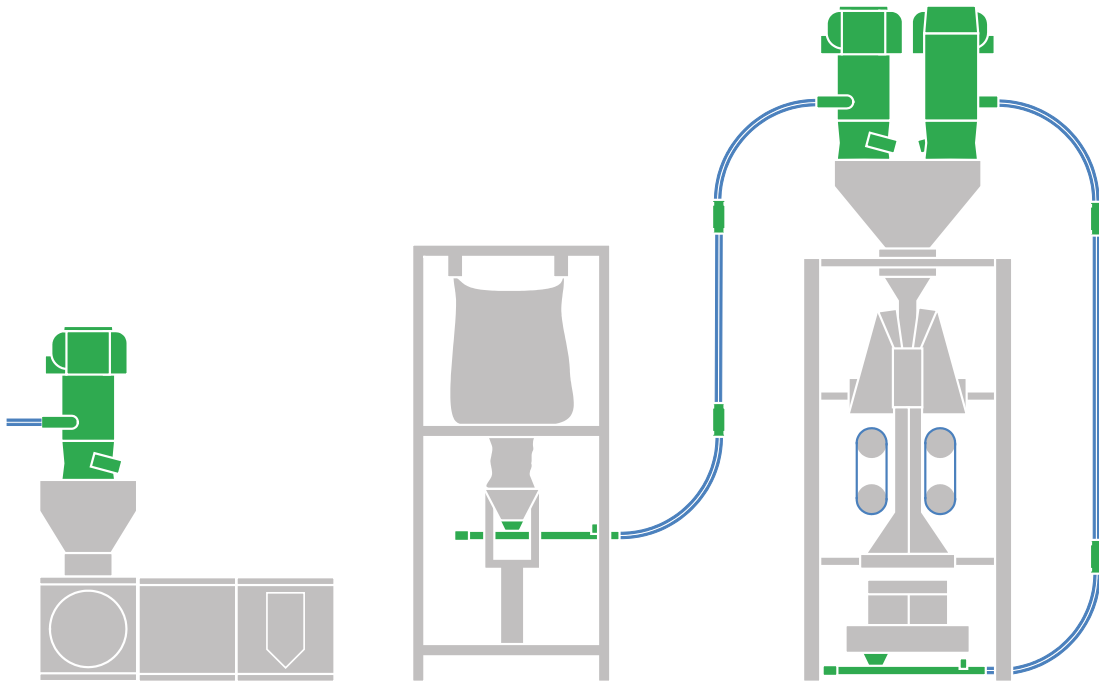

Instant coffee in big sacks/container with coffee and additives. Conveying to portioning machine. Into packaging machine and bags. Reclaiming back to packaging machine.

Seasoning or sugar/salt application:
piFLOW®p normally used.

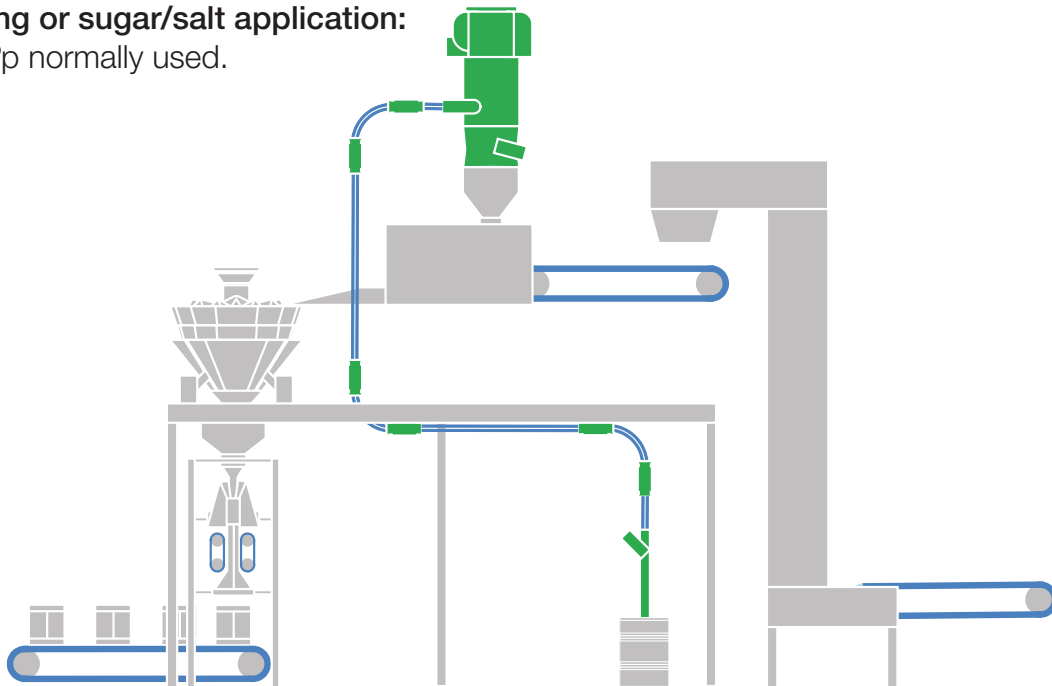

Conveying seasoning/salt/sugar to a seasoning machine with piFLOW®p conveyor. Into sorting and packaging machine then out to transportation belt.

7.3 Industry applications

Plastic granules:

piFLOW®i normally used.

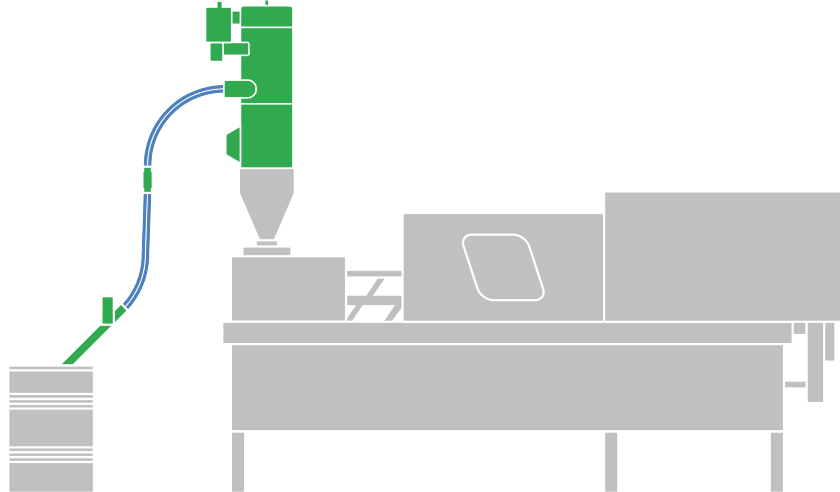

7.4 General applications

All piFLOW® models used.

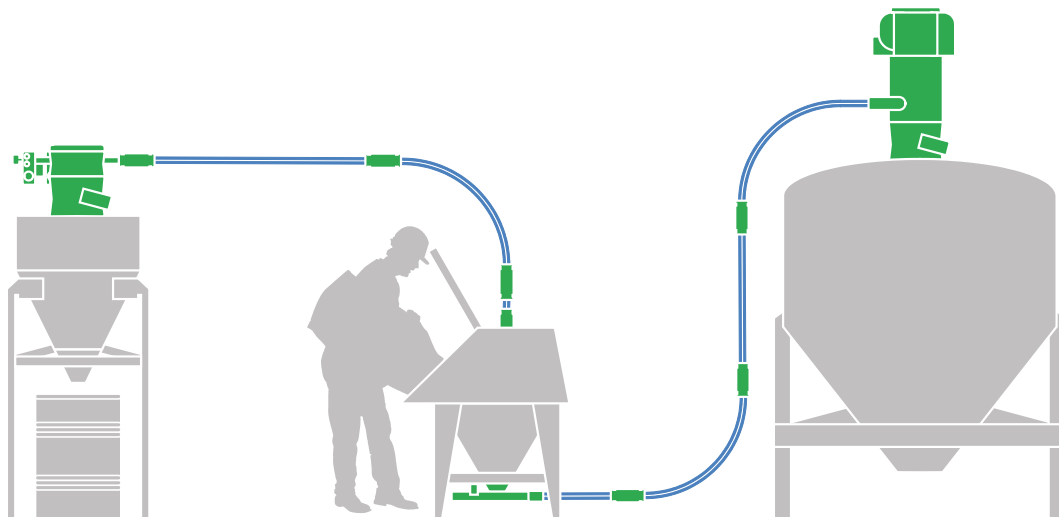

Bag dump station with conveying to a hopper as well as dust collection.

All piFLOW® models used.

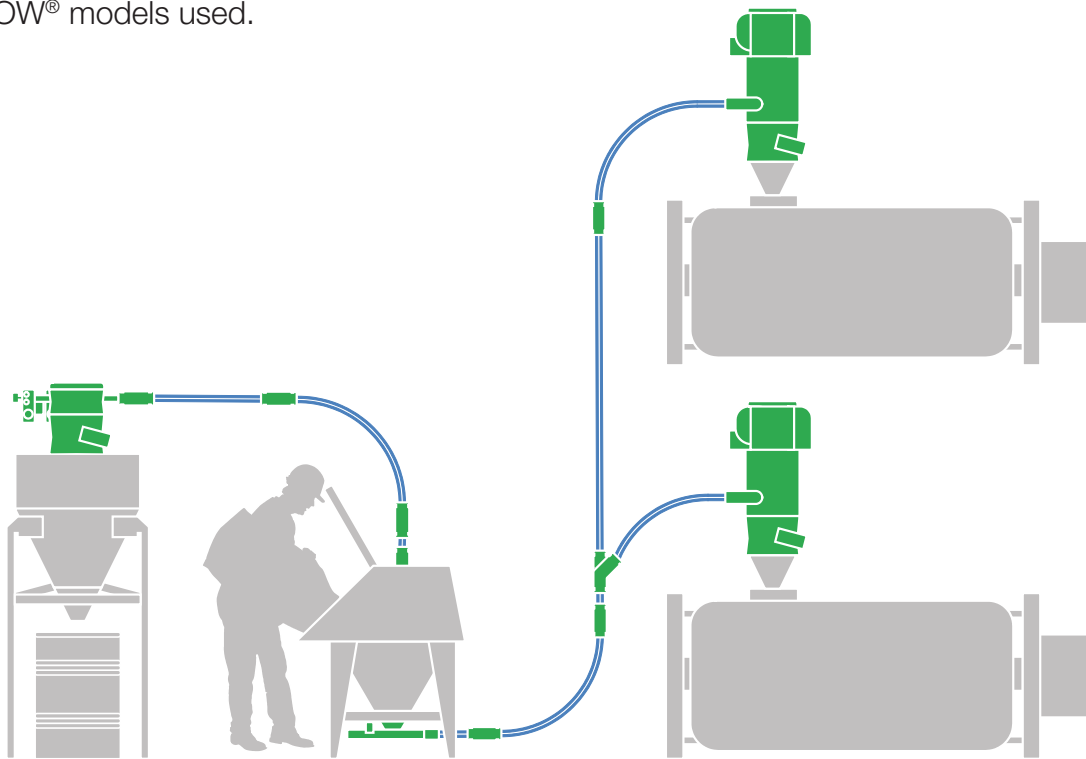

Bag dump station with conveying feed split to two blenders and dust collection.

8. Vacuum pumps

8.1 Compressed air-driven ejector pumps

All ejector pumps are driven with pressurised gas, usually compressed air. The compressed air flows into the ejector pump, where it expands in one or more ejector nozzles. When expanding, the stored energy (pressure and heat) is converted into motion energy. The speed of the compressed air jet increases rapidly, while the pressure and the temperature go down, attracting more air and thereby creating a vacuum on the suction side. Some ejector pumps may also be used to blow air.

Piab uses a patented technology for its

ejectors, the COAX® technology. It is a three stage ejector and the most energy efficient ejector available today. Its advantages is that it provides high efficiency, low energy consumption and operates even at low feed pressures. It is extremely easy to clean and also to upgrade later on when the vacuum needs have increased.

8.2 Mechanical pumps

The main principle for all mechanical pumps is that they convey, in one way or another, a certain volume of air from the suction side (the vacuum side) to the exhaust side. In that way they create a vacuum. Mechanical pumps usually have an electric motor as power source.

9. Tables

In everyday speech, many different expressions and units are used for both pressure and flow. It is important to agree on what is meant by them.

9.1 Pressure

$P=F/A$ (Force/Area).

SI unit (Système International d'Unités): Pascal (Pa). 1 Pa = 1 N/m². Common multiple units: MPa and kPa.

Pa (N/m ²)	bar	atm (kp/cm ²)	torr	psi (lb/in ²)
1	0.00001	10.1972x10 ⁻⁶	7.50062x10 ⁻³	0.145038x10 ⁻³
100 000	1	1.01972	750.062	14.5038
98 066.5	0.980665	1	735.559	14.2233
133.322	1.33322x10 ⁻³	1.35951x10 ⁻³	1	19.3368x10 ⁻³
6 894.76	68.9476x10 ⁻³	0.145038x10 ⁻³	51.7149	1

1 torr = 1 mm HG à 0° C,

1 mm column of water = 9.81 Pa.

9.2 Pressure above atmospheric

kPa	bar	psi	atm (kp/cm ²)
1013	10.13	146.9	10.3
1000	10	145	10.2
900	9	130.5	9.2
800	8	116	8.2
700	7	101.5	7.1
600	6	87	6.1
500	5	72.5	5.1
400	4	58	4.1
300	3	43.5	3.1
200	2	29	2
100	1	14.5	1
0	0	0	0

9.3 Pressure below atmospheric

	kPa	mbar	torr	-kPa	-mmHg	-inHg	% vacuum
Sea level	101.3	1013	760	0	0	0	0
	90	900	675	10	75	3	10
	80	800	600	20	150	6	20
	70	700	525	30	225	9	30
	60	600	450	40	300	12	40
	50	500	375	50	375	15	50
	40	400	300	60	450	18	60
	30	300	225	70	525	21	70
	20	200	150	80	600	24	80
	10	100	75	90	675	27	90
Absolute vacuum	0	0	0	101.3	760	30	100

9.4 Change in atmospheric pressure in relation to altitude (height above sea level)

A vacuum gauge is normally calibrated with normal atmospheric pressure at sea level as a reference, 14.7 psi, and is influenced by the surrounding atmospheric pressure in accordance with the table below.

Barometric pressure		The reading on the vacuum gauge at 14.7 psi					
mmHg	psi	Equivalent ft above sea level	18 -inHg	22.5 -inHg	25.5 -inHg	27 -inHg	29.7 -inHg
593	11.4	6,562	11.7	16.2	19.2	20.7	23.4
671	12.9	3,281	14.8	19.4	22.4	23.9	26.6
690	13.3	2,553	15.6	20.1	23.1	24.6	27.3
700	13.5	2,149	16.0	20.5	23.5	25.0	27.7
710	13.7	1,788	16.4	20.9	23.9	25.4	28.1
720	13.9	1,532	16.8	21.3	24.3	25.8	28.5
730	14.1	902	17.2	21.7	24.7	26.2	28.9
740	14.3	656	17.6	22.1	25.1	26.6	29.3
750	14.5	364	17.9	22.4	25.4	26.9	29.6
760	14.7	0	18.0	22.5	25.5	27.0	29.7

* At normal barometric pressure.

The vacuum gauge shows the differential pressure between atmospheric pressure and absolute pressure. This means that the gauge shows what vacuum level is available at different heights.

9.5 Flows

Flows, volume per unit of time.

Quantity designations: Q,

q, = V/t (volume/time).

SI Unit: cubic metres per second (m³/s).

Common multiple units: scfm, l/min, l/s, m³/h.

m ³ /s	m ³ /h	l/min	l/s	ft ³ /min (cfm)*
1	3600	60000	1000	2118.9
0.28x10 ⁻³	1	16.6667	0.2778	0.5885
16.67x10 ⁻⁶	0.06	1	0.0167	0.035
1x10 ⁻³	3.6	60	1	2.1189
0.472x10 ⁻³	1.6992	28.32	0.4720	1

* 1 ft ≈ 0.305 m.

9.6 Volume flow versus gas flow

Unit		Vacuum level -inHg										
		0	3	6	9	12	15	18	21	24	27	29
Volume flow	cfm	21.2	21.2	21.2	21.2	21.2	21.2	21.2	21.2	21.2	21.2	0
	m ³ /h	36	36	36	36	36	36	36	36	36	36	0
Free air	scfm	21.2	19.1	17.0	14.8	12.7	10.6	8.48	6.36	4.24	2.12	0
	Nm ³ /h	36	32.4	28.8	25.2	21.6	18	14.4	10.8	7.2	3.6	0

9.7 Leakage flows

The table below shows the leakage flow at different levels and through an opening of 1 in².

Vacuum level -inHg	Leakage flow cf/m and in ²
3.0	167
6.0	222
9.0	253
12.0	268*

* From about 13.0 to 29.5 -inHg the flow is constant.

9.8 Pressure drop in compressed air hoses

When installing compressed air hoses, it is important that the dimension (diameter) and length do not lead to excessive pressure drops. Piab vacuum pumps are supplied with recommended hose dimensions that will not cause excessive pressure drops at lengths below 2 m.

In cases when the pressure drop has to be calculated, the formula below can be used.

ΔP	=	Pressure drop in psi
qv	=	Flow in scfm
d	=	Inner diameter in in.
L	=	Length of compressed air hoses in ft
P1	=	Absolute starting pressure in psi

$$\Delta P = \frac{6.82 \times 10^{-4} \times qv^{1.85} \times L}{d^5 \times P1}$$

$$d = \left(\frac{6.82 \times 10^{-4} \times qv^{1.85} \times L}{\Delta P \times P1} \right)^{0.2}$$

9.9 Weight

	kg	g	oz	lb
1 kg	1	1000	35.27	2.205
1 g	0.001	1	0.03527	0.002205
1 oz	0.02835	28.35	1	0.0625
1 lb	0.4536	453.6	16	1

9.10 Force

Force	
1 N	0.10197 kp
1 kp	9.8066 N
1 N	0.2248 lbf
1 lbf	4.4482 N

9.11 Temperature

Melting point of ice	Boiling point of water at 29.9 -inHg	Absolute zero
0 °C	100 °C	-273.15 °C
32 °F	212 °F	-459.67 °F
273.15 K	373.15 K	0 K

$$^{\circ}F = 1.8(^{\circ}C) + 32.$$

9.12 Particle and filter pore size

Mesh	Micron	Inches
4	5205	0.2030
8	2487	0.0970
10	1923	0.0750
14	1307	0.0510
18	1000	0.0394
20	840	0.0331
25	710	0.0280
30	590	0.0232
35	500	0.0197
40	420	0.0165
45	350	0.0138
50	297	0.0117
60	250	0.0098
70	210	0.0083
80	177	0.0070
100	149	0.0059
120	125	0.0049
140	105	0.0041
170	88	0.0035
200	74	0.0029
230	62	0.0024
270	53	0.0021
325	44	0.0017
400	37	0.0015*
550	25	0.0009
800	15	0.0006
1250	10	0.0004
...	5	0.0002
...	1	0.000039

* *Threshold of visibility.*

10. Standards

10.1 Verification and validation – Acceptance test protocol

Verification is intended to check that a product, service, or system (or portion thereof, or set thereof) meets a set of design specifications.

Verification of machinery and equipment usually consists of design qualification (DQ),

installation qualification (IQ), operational qualification (OQ), and performance qualification (PQ).

To support the customers' own IQ/OQ certification, Piab can offer IQ/OQ documentation.

The Installation Qualification IQ is the documented proof that facilities and equipment have been delivered and installed in accordance with the requirements and statutory safety regulations stipulated in the design qualification.

The Operation Qualification OQ is a test process that evaluates the correct functioning of a facility or an appliance. During the Operation Qualification OQ, all items specified in the test plan are processed and documented in writing, to ensure that the system functions in accordance with specifications. The Operation Qualification OQ may only be performed after a successfully completed Installation Qualification IQ.

10.2 Inspection documents

The European inspection documents for deliveries of steel products are defined in EN 10204:2004 Metallic products, Types of inspection documents. In addition to the type of inspection documents the standard defines the provider of the documents i.e. validator, and the basis of the documents, that is, whether the documents are based on non-specific or specific inspection.

Types of inspection documents

- Declaration of compliance with the order 2.1 - EN 10204:2004.
- Test report 2.2 - EN 10204:2004.
- Inspection certificate 3.1 - EN 10204:2004.
- Inspection certificate 3.2 - EN 10204:2004.

EN 10204:2004 divides inspection documents into two main classes: Non-specific inspection documents are the declaration of compliance with the order 2.1 and the test report 2.2. Specific inspection documents are the inspection certificate 3.1 and inspection certificate 3.2. These two inspection certificates differ from each other in who verifies that the product is in accordance with the order and in who signs the inspection document.

Piab can offer Test report 2.2 - EN 10204:2004. With the type 2.2 test report document, document the steel works declares that the products are in accordance with the order. In the test report the quality control test results based on non-specific inspection are given, in accordance with the general material standards. The test results are not necessarily those from the lot supplied to the customer.

10.3 REGULATION (EC) No 1935/2004

REGULATION (EC) No 1935/2004 is an European regulation concerning materials and articles intended to come into contact with food.

The basic requirements of the regulation are that materials in contact with food

- must not endanger human health.
- must not bring unacceptable change to the food composition.
- must not bring deterioration to the food, for example regarding taste and odour.
- must not be labelled, advertised and presented in a misleading way.
- shall be traceable throughout the production chain.

10.4 ATEX

ATEX derives its name from the French title of the 94/9/EC directive:

Appareils destinés à être utilisés en
ATmosphères **EX**plosibles.

The ATEX directive consists of two EU directives describing what equipment and work environment is allowed in an environment with an explosive atmosphere.

ATEX 95 equipment directive 94/9/

EC (followed by Piab) = Equipment and protective systems intended for use in potentially explosive atmospheres.

ATEX 137 workplace directive 99/92/EC

(followed by plant owners) = Minimum requirements for improving the safety and health protection of workers potentially at risk from explosive atmospheres.

There are two different types of ATEX

certification for a conveyor, ATEX Dust and ATEX Gas.

Areas classified into different zones (0, 1, 2 for gas-vapor-mist and 20, 21, 22 for dust) must be protected from effective sources of ignition. Equipment and protective systems intended to be used in specified zones must meet the requirements of the directive.

Zone definitions

Gas, Mists or Vapors

- Zone 0 – An atmosphere where a mixture of air and flammable substances in the form of gas, vapor or mist is present frequently, continuously or for long periods.
- Zone 1 – An atmosphere where a mixture of air and flammable substances in the form of gas, vapor or mist is likely to occur in normal operation occasionally.
- Zone 2 – An atmosphere where a mixture of air and flammable substances in the form of gas, vapor or mist is not likely to occur in normal operation but, if it does occur, will persist for only a short period.

Dusts

- Zone 20 – An atmosphere where a cloud of combustible dust in the air is present frequently, continuously or for long periods.
- Zone 21 – An atmosphere where a cloud of combustible dust in the air is likely to occur in normal operation occasionally.
- Zone 22 – An atmosphere where a cloud

of combustible dust in the air is not likely to occur in normal operation but, if it does occur, will persist for only a short period.

Zone 0 and 20 are the zones with the highest risk of an explosive atmosphere being present.

Zone 0 and 20 require Category 1 marked equipment.

Zone 1 and 21 required Category 2 marked equipment.

Zone 2 and 22 required Category 3 marked equipment.

10.5 Machine directive

The Machinery Directive specifies the essential health and safety requirements applying to all machinery placed on the market within the EU. Based on the requirements of the Directive must CE marking made by the machinery placed on the European market, this shows that the machine can be freely sold in the European market since it satisfies the Machinery Directive and any other requirements.

CE 2A = pump, body, bottom valve and control

CE 2B = the customer has to do the declaration of conformity with all his different equipment at his site

10.6 Food contact regulations

The **Food and Drug Administration (FDA)** is an agency of the United States Department of Health and Human Services.

The **Code of Federal Regulations (CFR)** is the codification of the general and permanent rules and regulations published in the Federal Register by the executive departments and agencies of the federal government of the United States. The CFR is divided into 50 titles that represent broad areas subject to federal regulation. CFR 21 covers everything from what the food and drug should contain to how the equipment that is involved in the making of the food or drug should be made of accepted materials.

10.7 USDA

The **United States Department of Agriculture (USDA)**, also known as the **Agriculture Department**, is the U.S. federal executive department responsible for developing and executing federal government policy on farming, agriculture, forestry, and food. USDA has regulation for how equipment to dairy industries has to be designed. The USDA guidelines are close connected to 3-A sanitary standards.

piFLOW®

Piab's product series is called piFLOW® and it is offered in three models, the piFLOW®i for industrial applications, the piFLOW®f that is in the industry where food grade quality is a demand and piFLOW®p for premium applications such as food and pharmaceutical.



They have many things in common, but also many things that differentiate them. One main thing that they all have in common is the energy efficient way of producing vacuum. They are all built on using compressed air and COAX® cartridges for creating vacuum with compressed air. The COAX® cartridges are smaller, more efficient and more reliable than

conventional ejectors, which allows for the design of a flexible, modular and efficient vacuum system. A vacuum system based on COAX® technology can provide you with three times more vacuum flow than conventional systems, while reducing energy consumption.

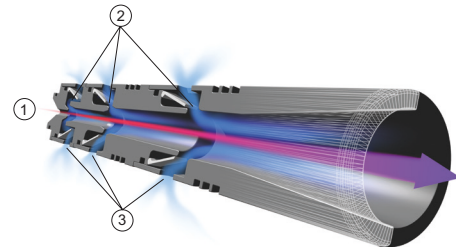

When compressed air (1) passes through the nozzles (2), air is pulled through with the stream of compressed air. Suction will be generated at the opening of each stage (3), resulting in vacuum.



Pump piBASIC suitable for piFLOW®i and piFLOW®f.



Pump piPREMIUM suitable for piFLOW®p.

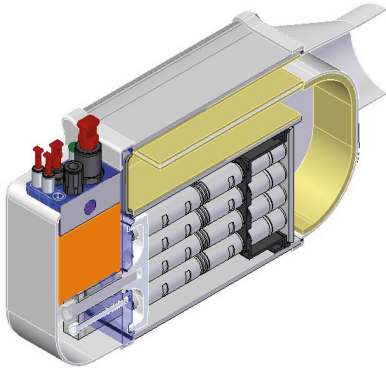

Pump piPREMIUM cross section.







piFLOWI®i/f cross section.

There are some advantages and features that goes across the three product lines.

- As they are all configurable, you can build the exact conveyor to your need and over time change just the part that needs changing, such as adding extra volume when the capacity need has increased.
 - The modularity makes them easy to maintain and clean so you can keep the changeover time as low as possible and increase the productivity.
 - Apart from having very small conveyors the three series of the piFLOW® are constructed to be very compact, for example such as having the pump side mounted to provide flexibility when you have limited space but still large conveying needs.
 - As the whole conveying principle is based on vacuum you will be able to have a solution that contributes to a dust free conveying and probably a better working environment.
- As the pump is using the world's most energy efficient ejector- the COAX® technology you are ensured that you have an energy efficient conveyor.
 - They have all the possibility to be equipped with a filter that has a filtration between 0.5 to 5 µm.
 - The conveyor comes with a 5 years warranty.
 - Fully pneumatic system, including the controls.

Here is some guidance on which conveyor line to choose:



	Standards	piFLOW®i	piFLOW®f	piFLOW®p
ATEX dust		●	●	●
ATEX gas				●
FDA*			●*	●
USDA**				●**
EC 1935/2004			●	●
IQ/OQ				●
Steel quality		ASTM 304	ASTM 304	ASTM 316L
Surface finish		Ra<3.2	Ra<3.2	Ra<0.6
Max capacity		5 tons/hrs	5 tons/hrs	14 tons/hrs
Fluidization				●

* All materials in contact with the conveyed product fulfill the requirements of FDA.

** piFLOW®p is designed according to USDA dairy guideline.

piFLOW®i



piFLOW®i 6



piFLOW®i 8



piFLOW®i 14

This is a conveyor that is widely used in general industry and sometimes in the chemical industry. It has a high throughput performance as well as a small footprint. This conveyor is often used as an alternative to mechanical conveyors when there is requirement for dust free conveying or a need for low maintenance.

The piFLOW®i series is designed with a full opening option making it possible for you to maximize the material throughput and increase the overall capacity of the system. The full opening gives an instant discharge, i.e. increased material throughput.

piFLOW[®]i – Overview

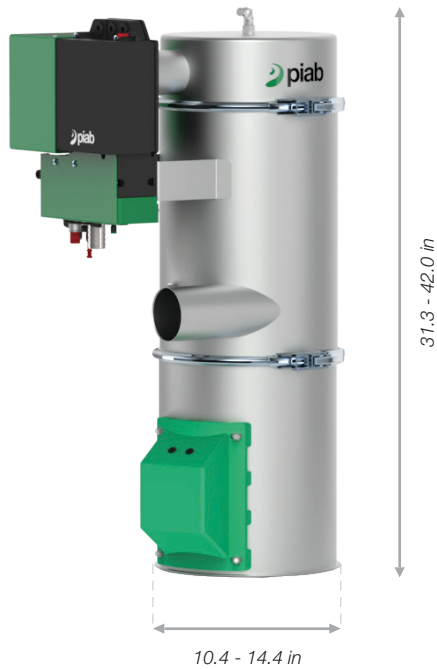

- Regulator kit 1" included
- Low noise level
- ATEX conformity optional
- EPDM seals, antistatic
- Actuator in aluminum
- Cone opening with 6 liters (0.21 cf)
- Full opening with 8 or 14 liters (0.28 or 0.49 cf)

Technical data

Description	Unit	Value
Material		ASTM 304, EPDM, NBR, ePTFE, PTFE, PE, PET, PA, Al, Zn
Temperature range	°F	32-140
Weight	lb	59.4-77.0
Feed pressure, max.	psi	101.5
Feed pressure range	psi	58-87
Air consumption range	scfm	10.6-78.4
Vacuum range	-inHg	18-22.2
Noise level range	dBA	69-77
Filter area	ft ²	0.97-5.38
Material batch volume	cf	0.21, 0.28 or 0.49
Feed pressure range, control	psi	58-87

piFLOW[®]f



piFLOW[®]f 6



piFLOW[®]f 8



piFLOW[®]f 14

This is a conveyor widely used in the industry where food grade quality is a demand. It has a high throughput performance as well as a small footprint. This conveyor is often used as an alternative to mechanical conveyors when there is a requirement for dust free conveying or low maintenance.

Our food grade conveyors are designed with a Stainless Steel body (ASTM 304) and seals in direct product contact zones that are in compliance of FDA to meet the demands of industrial food grade applications.

piFLOW[®]f – Overview



- Regulator kit 1" included
- Low noise level
- ATEX conformity optional
- Actuator in aluminum
- Cone opening with 6 liters (0.21 cf)
- Full opening with 8 or 14 liters (0.28 or 0.49 cf)
- All seals in direct contact with the conveyed product are in compliance with FDA

Technical data

Description	Unit	Value
Material		ASTM 304, EPDM, NBR, ePTFE, PTFE, PE, PET, PA, Al
Temperature range	°F	32-140
Weight	lb	59.4-77.0
Feed pressure, max.	psi	101.5
Feed pressure range	psi	58-87
Air consumption range	scfm	10.6-78.4
Vacuum range	-inHg	18-22.2
Noise level range	dBA	69-77
Filter area	ft ²	0.97-5.38
Material batch volume	cf	0.21, 0.28 or 0.49
Feed pressure range, control	psi	58-87

piFLOW[®]p



piFLOW[®]p 2



piFLOW[®]p 3



piFLOW[®]p 14



piFLOW[®]p 56

The piFLOW[®]p is best used when a premium technology is needed, e.g. in the food and pharmaceutical industries.

Typical applications:

- Powder and granules transfer
- Form-fill-seal
- Big bag loading and unloading
- Drum/bag filling and emptying
- Mill/Sieve/Mixer/Blender filling
- Tablet/fragile products transfer
- Applications in explosive atmosphere
- Hygienic applications
- Compact applications

piFLOW[®]p – Overview



- Designed mainly for industries handling food, chemical and pharmaceutical products
- Low noise level
- Automatic filter cleaning
- All materials in contact with the conveyed product fulfil the requirements of FDA, and designed according to USDA dairy guideline
- Optionally available with ATEX certificate and / or IQ / OQ and/or 2.2 certificate

Technical data

Description	Unit	Value
Material		ASTM 316L, EPDM, Q, NBR, ePTFE, PTFE, PE, PET, PA, Al, SS, PP
Temperature range	°F	32-140
Weight	lb	24.3-247
Feed pressure, max.	psi	101.5
Feed pressure range	psi	58-87
Air consumption range	scfm	5.30-237
Vacuum range	-inHg	18-22.2
Noise level range	dBA	69-77
Filter area	ft ²	0.33-75.3
Min. particle size	µm	0.5 or 5
Material batch volume	cf	0.07-1.98
Feed pressure range, control	psi	58-87

piFLOW® – Conveyor Customer Code



Model	Code
piFLOW®i	I
piFLOW®f	F



Pump size	Code
piBASIC100	BA100
piBASIC200	BA200
piBASIC400	BA400
piBASIC600	BA600
No pump	0



Filter type	Code
Textile filter 02	TX2
Textile filter 04	TX4
Textile filter 06	TX6
Pleated filter 02	P2
Pleated filter 04	P4
Pleated filter 06	P6
Pleated rod filter 02	PR2
Pleated rod filter 04	PR4
Pleated rod filter 06	PR6



Inlet diameter	Code
Inlet Ø 32 (1 ¼")	32
Inlet Ø 38 (1 ½")	38
Inlet Ø 51 (2")	51
Inlet Ø 63 (2 ½")	63
Inlet Ø 76 (3")	76
No Inlet	0



Batch volume	Code
Volume 6L (0.21 cf)	6
Volume 8L (0.28 cf)	8A
Volume 14L (0.49 cf)	14A
No volume	0

Model	Code
piFLOW®p	P

Pump size	Code
piPREMIUM64	P64
piPREMIUM100	P100
piPREMIUM200	P200
piPREMIUM400	P400
piPREMIUM600	P60L
piPREMIUM800	P80L
piPREMIUM1200	P120L
piPREMIUM1600	P160L
Vacuum Conn. 2.5"	VC2
Vacuum Conn. 3"	VC3
Vacuum Conn. 4"	VC4

Filter type	Code
Textile filter 01	TX1
Textile filter 02	TX2
Textile filter 04	TX4
Textile filter 06	TX6
Pleated filter 00	P0
Pleated filter 02	P2
Pleated filter 04	P4
Pleated filter 06	P6
Pleated rod filter 00	PR0
Pleated rod filter 01	PR1
Pleated rod filter 02	PR2
Pleated rod filter 04	PR4
Pleated rod filter 06	PR6

Inlet diameter	Code
TC Inlet Ø 25 (1")	25T
TC Inlet Ø 51 (2")	51T
TC Inlet Ø 76 (3")	76T
TC Inlet Ø 102 (4")	102T
Inlet Ø 25 (1")	25
Inlet Ø 32 (1 ¼")	32
Inlet Ø 38 (1 ½")	38
Inlet Ø 51 (2")	51
Inlet Ø 63 (2 ½")	63
Inlet Ø 76 (3")	76
Inlet Ø 102 (4")	102
No Inlet	0

Batch volume	Code
Volume 2L (0.07 cf)	2
Volume 3L (0.11 cf)	3
Volume 7L (0.25 cf)	7
Volume 14L (0.49 cf)	14
Volume 33L (1.17 cf)	33
Volume 56L (1.98 cf)	56
No volume	0

I . BA100 . TX2 . 32 . 6 . C . RS . AAL . EX . GB



Discharge type	Code
Cone Opening	C
Full Opening	F
No discharge	0



Control	Code
Control VU EP-1	EP
Control PPT/RS	RS
No control	0



Material	Code
Antistatic & AL	AAL



Special Technical documents	Code
ATEX	EX
No special documentation	0



Language	Code
Manual SE	SE
Manual GB	GB
Manual DE	DE
Manual IT	IT
Manual ES	ES
Manual FR	FR
Manual US	US
Manual DK	DK
Manual FI	FI
Manual NL	NL
Manual PL	PL
Manual PT	PT
Manual RO	RO
Manual CZ	CZ
Manual NO	NO
Manual RU	RU
Manual JP	JP

Discharge type	Code
Cone Opening	C
Full Opening	F
Cone Opening, bridging	CB
No discharge	0

Control	Code
Control VU EP-1	EP
Control CU-1A	1A
Control CU-1B	1B
Control CU-2A	2A
Control CU-2B	2B
Control PPT/RS	RS
No control	0

Material	Code
Antistatic & AL	AAL
Antistatic & SS	ASS
Silicon & AL	QAL
Silicon & SS	QSS





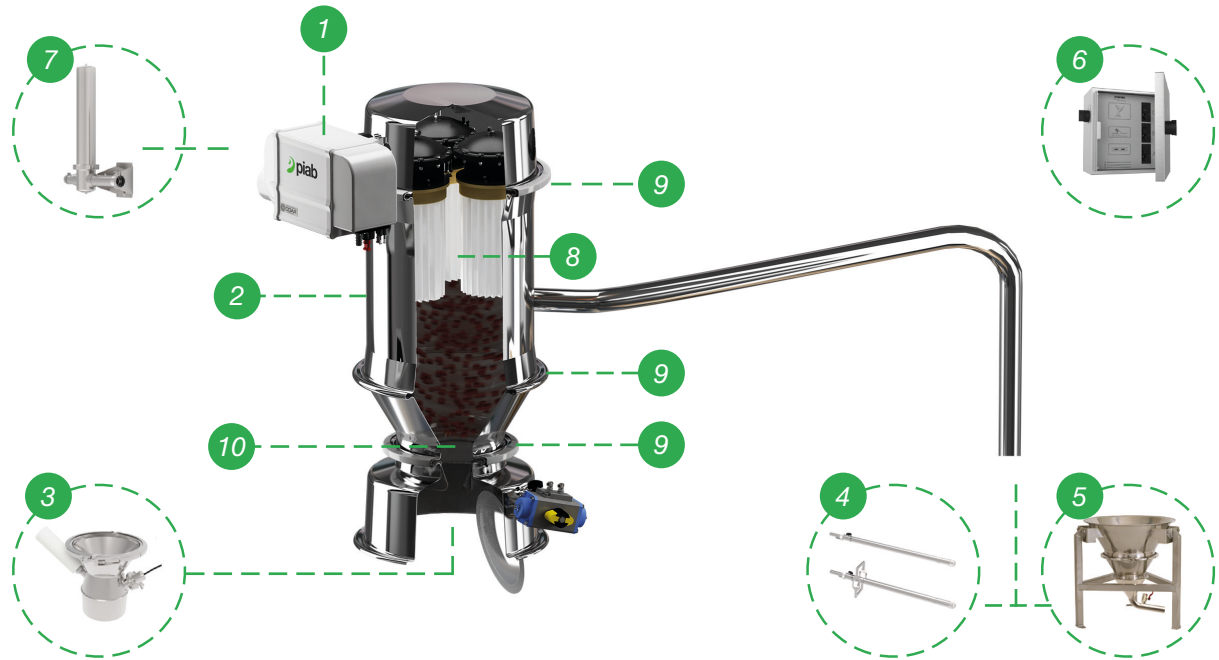

Special Technical documents	Code
ATEX	EX
2.2	2
IQ/OQ	Q
ATEX + 2.2	EX2
IQ/OQ + ATEX	QEX
IQ/OQ + 2.2	Q2
IQ/OQ + 2.2 + ATEX	Q2EX
No special documentation	0







Accessories & spare parts



- | | | | |
|---|--|----|-----------------|
| 1 | Vacuum pump | 6 | Control unit |
| 2 | Conveyor body | 7 | Sterile filter |
| 3 | Transition piece | 8 | Filters |
| 4 | Suction pipe, feed nozzle,
feed adapter | 9 | Seals |
| 5 | Feed station | 10 | Fluidizing cone |





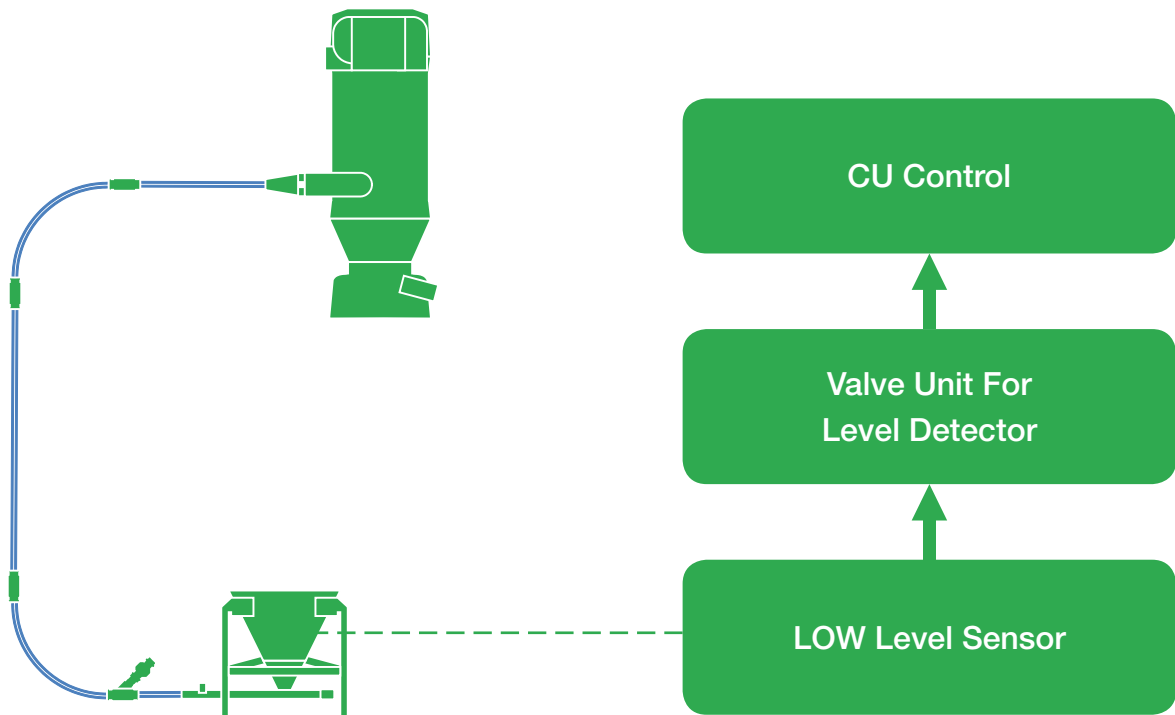

Accessories

			Suitable with piFLOW®			Features and benefits
			i	f	p	
1	Vacuum pumps	piBASIC 	●	●		<ul style="list-style-type: none"> Ejector driven pump with COAX® patented technology. Side mount for low building heights. High vacuum flow. Compact size and low weight. Low noise level. Modular design. 5 years warranty.
		piPREMIUM 			●	<ul style="list-style-type: none"> Ejector driven pump with COAX® patented technology. Side mount for low building heights. High vacuum flow. Compact size and low weight. Low noise level. Modular design. 5 years warranty.
	Valve unit for electro mechanical pump and piFLOW®		●	●	●	<ul style="list-style-type: none"> To optimize or complete a conveyor. Use together with electro mechanical vacuum pumps and Piab vacuum conveyor. Fully pneumatic. Wall mounting. Recommend to use with compressed air feed unit.
	Compressed air feed unit for electro mechanical pumps and piFLOW®		●	●	●	<ul style="list-style-type: none"> To optimize or complete a conveyor. Use together with electro mechanical vacuum pump and Piab vacuum conveyor. Fully pneumatic.
2	Conveyor body		●	●	●	<ul style="list-style-type: none"> Increase batch volume. Transition pieces. Increases distance between the filter and inlet.
3	Transition piece for tablet press				●	<ul style="list-style-type: none"> Use as a transition piece for tablet press. Ready to use, complete with sensor, aspiration filter, clamp ring and silicone sealing. Piab standard PR0 filter used for aspiration. Capacitive level sensor with TC connection. 3 m (10 ft) of cable with open end.







			Suitable with piFLOW®			Features and benefits
			i	f	p	
4	Suction pipes		●	●	●	<ul style="list-style-type: none"> ● For picking up powders and granules from barrels, hoppers and bags. ● The amount of carrying air can be adjusted via the ball valve, to allow for optimum air to product ratio. ● The inlet of the suction pipe is equipped with an arched steel wire to prevent bags from being drawn in to the pipe. ● The suction pipe diameter range matches the conveyor inlet and piping size range.
	Feed nozzles piFLOW®p				●	<ul style="list-style-type: none"> ● Polished \leq Ra 0.8. ● To pick up the product in a smooth manner. ● Adjustable air intake at two places. ● Available with TC connection. ● Dismantle without tools.
	Feed adapters				●	<ul style="list-style-type: none"> ● To optimize the feeding point (where the product is conveyed from) for the conveying system to assure maximum capacity and safe transport.
			●	●		<ul style="list-style-type: none"> ● To optimize the feeding point (where the product is conveyed from) for the conveying system to assure maximum capacity and safe transport.
5	Feed stations				●	<ul style="list-style-type: none"> ● To store the product at the suction point. ● Polished \leq Ra 0.8. ● Available with white or antistatic (black) fluidization cone. ● Fluidization regulator is included.
			●	●		<ul style="list-style-type: none"> ● To store the product at the suction point. ● Pickled in product contact zone \leq Ra 0.8.



If we consider a typical application requiring a level control. This example is for stopping the conveying process when the feed station is empty of product. In this case we are applying a low level sensor in the station via our valve unit for level detector to our CU control. This will stop the conveyor and reset the timers when material is low or the station is empty.

			Suitable with piFLOW®			Features and benefits
			i	f	p	
6	Control units	Control Unit PPT/RS 	●	●	●	<ul style="list-style-type: none"> Adjustable suction and discharge time. Controls the functions of the conveyor. Filter air shock signal. Fully pneumatic. Regulator to control the feed pressure to the actuator at the bottom lid. The maximum recommended distance between the conveyor and control unit is 33 feet when feed pressure is 87 psi. Start/Stop button.
		Control unit CU 			●	<ul style="list-style-type: none"> Controls the functions of the conveyor. Level sensor. Fluidized conveyor discharge. Fully pneumatic. Pipe emptying unit. Remote start/stop and emergency stop as an option. The maximum recommended distance between the conveyor and control unit is 33 feet when feed pressure is 87 psi.
		Valve unit VU-EP 	●	●	●	<ul style="list-style-type: none"> Valve unit with electro-pneumatic valves that can be used to control Piab's vacuum conveyors with external PLC or similar electrical control system. Simple installation: Prepared for connection to the vacuum conveyor's main functions; start the pump, close the bottom valve, open the bottom valve, fluidization and the filter shock. Prepared to be fitted with six electro-pneumatic valves. The unit is delivered with four valves and two unused spare positions. The valve unit has an electrical connection with an 8-pin M12x1 connector. The unit is delivered with a connection cable (L=6 ft) that is fitted with a connector at one end.
		Valve unit for level detector CU-1/2 			●	<ul style="list-style-type: none"> Provides an electrical to pneumatic signal allowing the CU control to switch the conveyor cycle on/off during operation and provides a control unit reset. Capacitive sensor needed. Sensor type 1 is a standard sensor. Type 2 is suitable for ATEX. Both options provides a 24VDC output, normally open electrical connection.
		Maintenance kit piFLOW® pumps 	●	●	●	<ul style="list-style-type: none"> Used for start-up and maintenance of a Piab conveying system Complete kit, ready to use. 4x10 m (33 ft) Nylon tubing D=4/2 included. Enables reading of vacuum and pressure levels. Actuating valve to start/stop the Piab pump. Fits all piFLOW®i, f and p conveyors fitted with Piab pump.
7	Other	Sterile filter 			●	<ul style="list-style-type: none"> Secondary sterile filter for piFLOW®p conveyor family. FDA approved. Easy to assemble / disassemble. Complete kit, ready to use. Filtration class ULPA 16 according to DIN EN 779 / DIN EN 1822-1:1998.

Spare parts

		Suitable with piFLOW®			Features and benefits	
		i	f	p		
8	Filters	Textile filter 	●	●	●	<ul style="list-style-type: none"> ● The filter bags are of food quality. ● Antistatic. ● Welded seams. ● Min particle size 5 µm.
		Pleated filter 	●	●	●	<ul style="list-style-type: none"> ● FDA compliance. ● The filter is antistatic and in compliance with ATEX. ● Suitable for extreme fine and free flowing powder, i.e. toner. ● Min particle size 0.5 µm.
		Pleated rod filter 	●	●	●	<ul style="list-style-type: none"> ● Suitable for fine powders, for example toner. ● FDA compliance. ● The grey pleated rod filter is antistatic and in compliance with ATEX. ● Min particle size 0.5 µm.
		Pleated rod filter 			●	<ul style="list-style-type: none"> ● Suitable for fine powders, for example toner. ● FDA compliance. ● Min particle size 0.5 µm.
9	Seals	Various seals 	●	●	●	<ul style="list-style-type: none"> ● Fulfils the requirements of FDA for piFLOW®f/p. ● EPDM material.
		Various seals 			●	<ul style="list-style-type: none"> ● Fulfils the requirements of FDA for piFLOW®p. ● Silicone material.
10	Fluidizing cone 			●	<ul style="list-style-type: none"> ● Fulfils the requirements of FDA. ● Antistatic (black cone). ● For bridging powder. 	

Filter selection & pipe sizing, piFLOW®p

Conveyor model	G = Powder w. part.size >25 µm (granules) P = Powder w. min part.size >10 µm FP = Powder w. min part.size >5 µm UFP = Powder w. min part.size >3 µm B = Bridging / Sticky powder	Pump piPREMIUM 64	Pump piPREMIUM 100	Pump piPREMIUM 200	Pump piPREMIUM 400	Pump piPREMIUM 600	Pump piPREMIUM 800	Pump piPREMIUM 1200	Pump piPREMIUM 1600
piFLOW®p, vol. 2, 3, 7L. 1 filter	TX1, Textile filter 01		G						
	TX2, Textile filter 02		P B	G					
	TX4, Textile filter 04		FP B	P B	G				
	PR0, Pleated rod filter 00	P B							
	PR1, Pleated rod filter 01		P B						
	PR2, Pleated rod filter 02		FP B	P B					
	PR4, Pleated rod filter 04		UFP B	FP B	P B				
	P0, Pleated filter 00	FP							
	P2, Pleated filter 02		UFP	UFP	P				
	P4, Pleated filter 04		UFP	UFP	FP				
piFLOW®p, vol. 14, 33L. 3 filters	TX2, Textile filter 02			P B	G	G			
	TX4, Textile filter 04			FP B	P B	G	G		
	TX6, Textile filter 06			FP B	P B	P B	G	G	
	PR2, Pleated rod filter 02			FP B	P B	P B			
	PR4, Pleated rod filter 04			UFP B	FP B	FP B	P B		
	PR6, Pleated rod filter 06			UFP B	UFP B	FP B	FP B	P B	
	P2, Pleated filter 02			UFP	UFP	FP	FP	P	
	P4, Pleated filter 04			UFP	UFP	UFP	FP	FP	P
	P6, Pleated filter 06			UFP	UFP	UFP	UFP	UFP	FP
piFLOW®p, vol. 56L. 7 filters	TX2, Textile filter 02					P B	G		
	TX4, Textile filter 04					P B	P B	G	
	TX6, Textile filter 06					FP B	FP B	P B	G
	PR2, Pleated rod filter 02					FP B	FP B	P B	
	PR4, Pleated rod filter 04					UFP B	FP B	FP B	P B
	PR6, Pleated rod filter 06					UFP B	FP B	F B	G B
	P2, Pleated filter 02					UFP	UFP	FP	FP
	P4, Pleated filter 04					UFP	UFP	UFP	UFP
	P6, Pleated filter 06					UFP	UFP	UFP	UFP

Model [piFLOW®p]	Conveyor body inlet diameter, mm [inch]	Bulk density 0.4-1.0 kg/L. 25-62.4 lb/cubic ft Recom. conveying pipe diameter Ø, mm [inch]	Bulk density 1.0-1.5 kg/L. 62.4-93.6 lb/cubic ft Recom. conveying pipe diameter Ø, mm [inch]	Bulk density 1.5-2.0 kg/L. 93.6 - 124.9 lb/cubic ft Recom. conveying pipe diameter Ø, mm [inch]
Pump 64 Vol. 2	25 [1]	25 [1]	25 [1]	25 [1]
Pump 100 Vol. 3	51 [2]	38 [1.5]	32 [1.26]	32 [1.26]
Pump 200 Vol.7	51 [2]	51 [2]	38 [1.5]	32 [1.26]
Pump 400 Vol. 14	76 [3]	63,5 [2.5]	51 [2]	38 [1.5]
Pump 600 Vol. 33	76 [3]	76 [3]	63,5 [2.5]	51 [2]
Pump 800 Vol. 33	76 [3]	76 [3]	76 [3]	63,5 [2.5]
Pump 800 Vol. 56	102 [4]	102 [4]	76 [3]	63,5 [2.5]
Pump 1200 Vol. 56	102 [4]	102 [4]	76 [3]	76 [3]
Pump 1600 Vol. 56	102 [4]	102 [4]	76 [3]	76 [3]

Legend piFLOW[®]p



Pump 64
Vol. 2 L



Pump 100/200/400
Vol. 3 L



Pump 100/200/400
Vol. 7 L



Pump 600/800
Vol. 14 L



Pump 600/800
Vol. 33 L



Pump 1200/1600
Vol. 56 L

Legend piFLOW®i/f



Pump 100/200/400/600
Vol. 6 L



Pump 100/200/400/600
Vol. 8 L



Pump 100/200/400/600
Vol. 14 L

Length capacity piFLOW®i/f

Length in feet	Capacity (Ton/h)											
	0,25	0,5	1	1,5	2	2,5	3	3,5	4	4,5	5	
160	Pump 600 Vol. 14	Pump 400/600 Vol. 14										
145	Pump 600 Vol. 14	Pump 400/600 Vol. 14										
130	Pump 400 Vol. 8	Pump 400/600 Vol. 14										
110	Pump 400 Vol. 8	Pump 400 Vol. 8/14										
95	Pump 400 Vol. 8	Pump 400 Vol. 8/14										
80	Pump 200 Vol. 6	Pump 400 Vol. 8/14	Pump 600 Vol. 14									
65	Pump 200 Vol. 6	Pump 200/400 Vol. 6/8	Pump 400/600 Vol. 14									
55	Pump 200 Vol. 6	Pump 200 Vol. 6/8	Pump 400 Vol. 8/14									
45	Pump 200 Vol. 6	Pump 200 Vol. 6/8	Pump 400 Vol. 8/14	Pump 600 Vol. 14								
40	Pump 100 Vol. 6	Pump 200 Vol. 6/8	Pump 400 Vol. 8/14	Pump 400 Vol. 14	Pump 600 Vol. 14							
30	Pump 100 Vol. 6	Pump 100/200 Vol. 6/8	Pump 200/400 Vol. 8	Pump 400 Vol. 14	Pump 600 Vol. 14							
20	Pump 100 Vol. 6	Pump 100 Vol. 6	Pump 200 Vol. 8	Pump 400 Vol. 8/14	Pump 400 Vol. 14	Pump 600 Vol. 14						
15	Pump 100 Vol. 6	Pump 100 Vol. 6	Pump 200 Vol. 8	Pump 200 Vol. 8	Pump 400 Vol. 14	Pump 400 Vol. 14	Pump 600 Vol. 14	Pump 600 Vol. 14	Pump 600 Vol. 14			
6	Pump 100 Vol. 6	Pump 100 Vol. 6	Pump 100 Vol. 6	Pump 100 Vol. 6	Pump 200 Vol. 7	Pump 200 Vol. 7	Pump 400 Vol. 14	Pump 400 Vol. 14	Pump 400 Vol. 14	Pump 600 Vol. 14	Pump 600 Vol. 14	

Filter selection & pipe sizing, piFLOW®i/f

Conveyor model		Pump piBASIC100	Pump piBASIC200	Pump piBASIC400	Pump piBASIC600
G = Powder w. part.size >25 µm (granules) P = Powder w. min part.size >10 µm FP = Powder w. min part.size >5 µm UFP = Powder w. min part.size >3 µm B = Bridging / Sticky powder					
piFLOW®i & f. 1 filter	TX2, Textile filter 02	P B	G		
	TX4, Textile filter 04	FP B	P B	G	
	TX6, Textile filter 06	FP B	FP B	PB	G
	PR2, Pleated rod filter 02	FP B	P B		
	PR4, Pleated rod filter 04	UFP B	FP B	P B	
	PR6, Pleated rod filter 06	UFP B	UFP B	FP B	PB
	P2, Pleated filter 02	UFP	UFP	P	
	P4, Pleated filter 04	UFP	UFP	FP	
P6, Pleated filter 06	UFP	UFP	UFP	P	

Model [piFLOW®i & f]	Conveyor body inlet diameter	Bulk density 0.4-1.0 kg/L. 25-62.4 lb/cubic ft	Bulk density 1.0-1.5 kg/L. 62.4-93.6 lb/cubic ft	Bulk density 1.5-2.0 kg/L. 93.6 - 124.9 lb/cubic ft
	Conveyor body inlet diameter, mm [inch]	Recom. conveying pipe diameter Ø mm [inch]	Recom. conveying pipe diameter Ø mm [inch]	Recom. conveying pipe diameter Ø mm [inch]
Pump 100 Vol. 6	76 [3]	38 [1.5]	32 [1.26]	32 [1.26]
Pump 100 Vol. 8	76 [3]	38 [1.5]	32 [1.26]	32 [1.26]
Pump 200 Vol. 6	76 [3]	51 [2]	38 [1.5]	32 [1.26]
Pump 200 Vol. 8	76 [3]	51 [2]	38 [1.5]	32 [1.26]
Pump 400 Vol. 8	76 [3]	63,5 [2.5]	51 [2]	38 [1.5]
Pump 200 Vol. 14	76 [3]	51 [2]	38 [1.5]	32 [1.26]
Pump 400 Vol. 14	76 [3]	63,5 [2.5]	51 [2]	38 [1.5]
Pump 600 Vol. 14	76 [3]	76 [3]	63,5 [2.5]	51 [2]

Warranties

Piab offers a warranty to distributors, integrators and users of Piab products worldwide as per the following definitions:

- A five-year warranty is valid for complete vacuum conveyors excluding blower pumps and controls.
- A five-year warranty is valid for vacuum pumps excluding blower pumps, accessories and controls.
- A one-year warranty is valid for other products.

General warranty principles:

- Piab guarantees against defects in the manufacture and materials by normal use in a proper environment, when following the instructions for care, maintenance and control described in the appropriate Piab manual.
- Piab replaces or repairs, free of charge, faulty products provided that these are returned to Piab and found to be covered by the warranty.
- It is at Piab's discretion whether a faulty product should be sent back to Piab for replacement or if the repair shall be made locally at Piab's expense.
- This warranty does not include wear parts such as filter elements, sealings, hoses, pipe fittings, pipe bends, pinch valves (in-line with conveyed material), reducers, etc.
- This warranty does not include subsequent damages caused by defective products.

AMERICAS

ARGENTINA

Piab Argentina S.A.
25 de Mayo 1807
San Martín
AR-1650 BUENOS AIRES
Phone: +54 11 4713 8550
Fax: +54 11 4713 8552
Email: info-argentina@piab.com

BRAZIL

Regional office South America
Piab do Brasil Ltda.
R. Capitão Joaquim da Silva Rocha, 50
Jardim Ana Maria
BR-13208-750 JUNDIAI – SP
Phone: +55 11 4492 9050
Fax: +55 11 4522 4066
Email: info-brasil@piab.com

MEXICO

Piab Mexico & Central América
65 Sharp Street
HINGHAM MA 02043 US
Phone: +1 781 337 7309
Fax: +1 781 337 6864
Email: info-mxca@piab.com

USA/CANADA

Regional office North America
Piab USA, Inc.
65 Sharp Street
HINGHAM MA 02043 US
Phone: +1 781 337 7309
Fax: +1 781 337 6864
Email: info-usa@piab.com

ASIA

CHINA

Piab (Shanghai) Co., Ltd
Unit 401, Blk B1, No. 6000 Shenzhuan Rd
Songjiang District
CN-201619 SHANGHAI
Phone: +86 21 5237 6545
Fax: +86 21 5237 6549
Email: info-china@piab.com

VIETNAM

Hoang Long Technology Co., Ltd
468 Le Hong Phong, Dist.10,
Ho Chi Minh City, Viet Nam
Phone: +84 28 38 398 999
Hotline: 0907 686 889
Email: hoanglongtechnology@gmail.com

INDIA

Piab Vacuum Technology Pvt. Ltd
Plot no 11/C8, 11th block,
Mugappair East,
IN-600 037 CHENNAI
Phone: +91 9444 25 36 48
Email: info-india@piab.com

JAPAN

Piab Japan Ltd.
8-43-17 Tateishi Katsushika-ku,
JP-124-0012 TOKYO
Phone: +81 3 6662 8118
Fax: +81 3 6662 8128
Email: info-japan@piab.com

SINGAPORE

Regional office Asia Pacific
Piab Asia Pte Ltd
4008 Ang Mo Kio Ave 10
03-16 Techplace 1
SG-569625 SINGAPORE
Phone: +65 6455 7006
Fax: +65 6455 0081
Email: info-singapore@piab.com

SOUTH KOREA

Piab Korea Ltd
C-2402 Daelim Acrotel
KR-Kangnam-Gu 467-6
DOKOK-DONG
Phone: +82 2 3463 0751
Fax: +82 2 3463 0754
Email: info-korea@piab.com

EUROPE

FRANCE

Piab
Parc d'entreprises L'Esplanade
10 rue Enrico Fermi
Saint-Thibault des Vignes
FR-77462 LAGNY SUR MARNE Cedex
Phone: +33 1 6430 8267
Fax: +33 1 6430 8285
Email: info-france@piab.com

GERMANY

Regional office Europe
Piab Vakuu GmbH
Otto-Hahn-Str. 14
DE-35510 BUTZBACH
Phone: +49 6033 7960 – 0
Fax: +49 6033 7960 – 199
Email: info-germany@piab.com

ITALY

Piab ITALIA Srl
Via Cuniberti, 58
IT-10151 TORINO
Phone: +39 011 226 36 66
Fax: +39 011 226 21 11
Email: info-italy@piab.com

POLAND

Piab Polska Sp. z o.o.
Ul. Astronomow 1
PL-80-299 GDANSK
Phone: +48 58 785 08 50
Fax: +48 58 785 08 51
Email: info-poland@piab.com

SPAIN

Vacío Piab, S.L.
Avda. Pineda, 2
CASTELLDEFELS
ES-08860 BARCELONA
Phone: +34 93 6333876
Fax: +34 93 6380848
Email: info-spain@piab.com

SWEDEN

Head office
Piab AB
Box 4501
SE-183 04 TÄBY
Phone: +46 8 630 25 00
Fax: +46 8 630 26 90
Email: info-sweden@piab.com

UNITED KINGDOM

Piab Ltd.
Unit 7 Oaks Industrial Estate
Festival Drive
LOUGHBOROUGH LE11 5XN
Phone: +44 1509 857 010
Fax: +44 1509 857 011
Email: info-uk@piab.com

No need to compromise



www.congnghehoanglong.com